

# CC, MSC, CMS

## MODULAR FUSE BASES

### MODULAR FUSE-LINK BASES FOR CARTRIDGE FUSE-LINKS

Ferraz Shawmut CC, MSC and CMS modular fuse bases accommodate industrial cylindrical fuse-links 8 x 31mm, 10 x 38mm, 14 x 51mm, and 22 x 58 mm, North American Class CC and Midget (1-1/2" x 13/32") fuses. They have operating handles for non load-break disconnecting and electrical isolation for fuse-link replacement without tools. All contacts are silver-plated. 2, 3 or 4-pole units can be made up with assembly pins and operating handle ties.

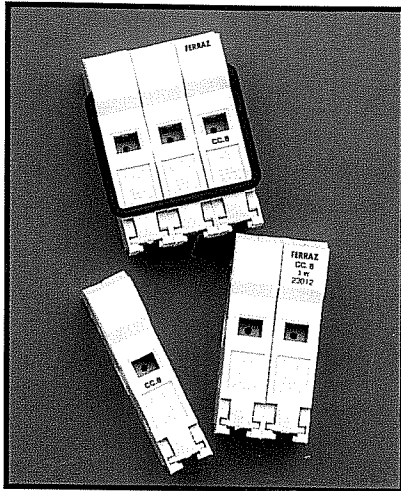

### CC Series

- **4 Size Ranges:**
  - CC.8** accepts 8 x 31mm fuse-links
  - CC.10** accepts Class CC, Midget and 10 x 38mm fuse-links
  - CC.14** accepts 30A/250V Class H/K/R & 14 x 51mm fuse-links
  - CC.22** accepts 22 x 58mm fuse-links
- Screw mount or symmetrical DIN rail mount (with adaptor)
- Steel bail handle tie
- Thermoplastic base

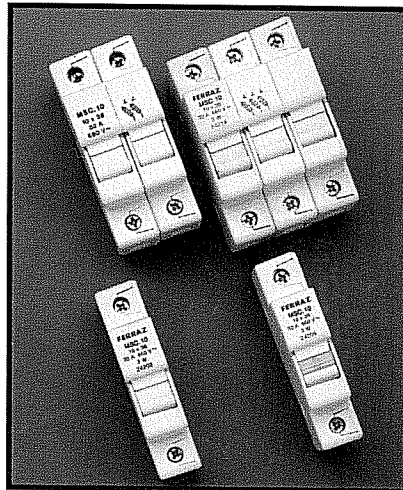

### MSC Series

- **2 Size Ranges:**
  - MSC.8** accepts 8 x 31mm fuse-links
  - MSC.10** accepts Class CC, Midget and 10 x 38mm fuse-links
- Symmetrical DIN rail mount
- Optional neutral incorporated
- Optional indicator light in 1-pole unit shows open fuse when lit
- Steel pin handle tie
- Thermoplastic base

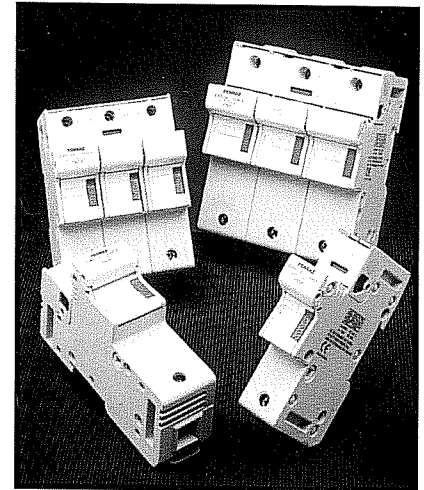

### CMS Series

- **2 Size Ranges:**
  - CMS.14** accepts 30A/250V Class H/K/R & 14 X 51mm fuse-links
  - CMS.22** accepts 22 x 58mm fuse-links
- Optional neutral incorporated
- Optional indicator light shows open fuse when lit
- Optional microswitch on 1-pole & 3-pole
- Thermoplastic base



# MSC.8, MSC.10

## MODULAR FUSE BASES

### MSC.8 – 25A, 400VAC, Fits 8 X 31mm Fuse-links

CATALOG POLES	No. of NUMBER	Width (No. of 17.5mm MODULES)	PACK
1	24002-G	1	12
1 + N*	24006-G	1	12
1 + N*	24010-G	2	6
2	24012-G	2	6
3	24014-G	3	4
3 + N*	24018-G	3	4
3 + N*	24016-G	4	3
4	24019-G	4	3
N*	24000-G	1	12



24002-G



24004-G

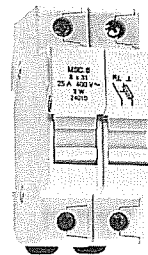

24010-G

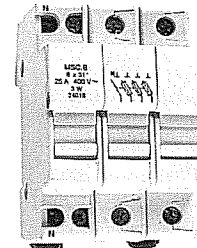

24018-G

#### With Built-in Indicator Light

1	24004-G	1	12
1 + N*	24008-G	1	12

\* with neutral incorporated

### MSC.10 – 32A, 690VAC, Fits Class CC, 1-1/2" x 13/32" and 10 x 38mm Fuse-links

POLES	CATALOG NUMBER	Width (No. of 17.5mm MODULES)	STANDARD PACK
1	24202-G	1	12
1 + N*	24206-G	1	12
1 + N*	24210-G	2	6
2	24212-G	2	6
3	24214-G	3	4
3 + N*	24218-G	3	4
3 + N*	24216-G	4	3
4	24219-G	4	3
N*	24200-G	1	12



24206-G



24208-G

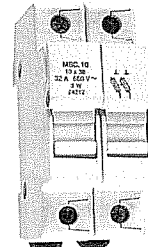

24212-G

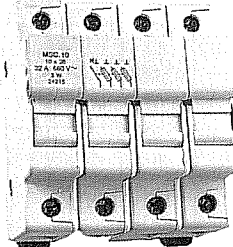

24216-G

#### With Built-in Indicator Light

1	24204-G	1	12
1 + N*	24208-G	1	12

\* with neutral incorporated

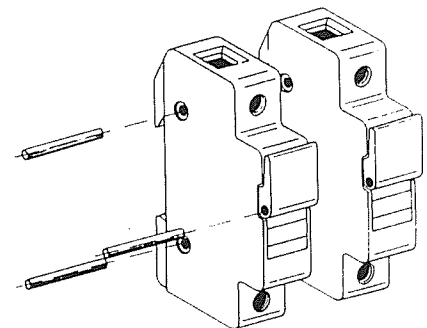
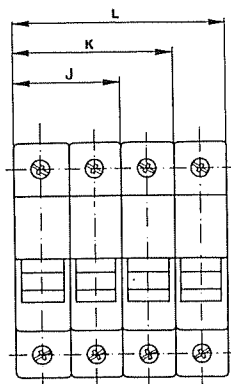
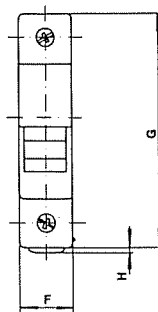
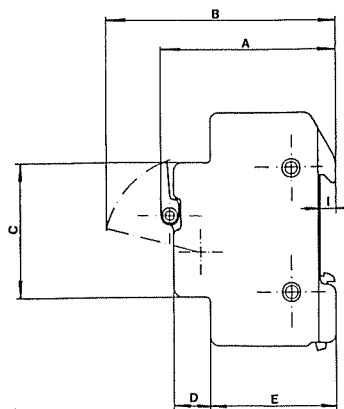

#### Assembly Pins

#### Dimensions – mm (Inches)

A	B	C	D	E	F	G	H	J	K	L
59 (2.32)	78 (3.07)	45 (1.77)	12.5 (.49)	42.5 (1.67)	17.5 (.69)	78 (3.07)	2.5 (.098)	35 (1.38)	52.5 (2.07)	70 (2.76)

No. of POLES	CATALOG NUMBER	STANDARD PACKAGE
2	14030-G	10
3	14031-G	10
4	14032-G	10