



**Capsule Thyristor**

## Line Thyristor

### SKT 1800

#### Features

- Hermetic metal case with ceramic insulator
- Capsule package for double sided cooling
- Shallow design with single sided cooling
- Off-state and reverse voltages up to 1600 V
- Amplifying gate

#### Typical Applications\*

- DC motor control (e. g. for machine tools)
- Controlled rectifiers (e. g. for battery charging)
- AC controllers (e. g. for temperature control)
- Soft starters for AC motors
- Recommended snubber network e. g. for  $V_{VRMS} \leq 400$  V:  
 $R = 33 \Omega / 32$  W,  $C = 1 \mu F$

$V_{RSM}$ V	$V_{RRM}, V_{DRM}$ V	$I_{TRMS} = 4500$ A (maximum value for continuous operation) $I_{TAV} = 1800$ A (sin. 180; DSC; $T_c = 85$ °C)	
1300	1200	SKT 1800/12E	
1500	1400	SKT 1800/14E	
1700	1600	SKT 1800/16E	

Symbol	Conditions	Values	Units
$I_{TAV}$	sin. 180; $T_c = 100$ (85) °C;	2500 (1270 )	A
$I_D$	2 x N4/250; $T_a = 45$ °C; B2 / B6	2500 / 3600	A
	2 x N4/400; $T_a = 45$ °C; B2 / B6	2800 / 4000	A
$I_{RMS}$	2 x N4/250; $T_a = 45$ °C; W1C	2800	A
$I_{TSM}$	$T_{vj} = 25$ °C; 10 ms	53000	A
	$T_{vj} = 125$ °C; 10 ms	45000	A
$i^2t$	$T_{vj} = 25$ °C; 8,3 ... 10 ms	14000000	A <sup>2</sup> s
	$T_{vj} = 125$ °C; 8,3 ... 10 ms	10000000	A <sup>2</sup> s
$V_T$	$T_{vj} = 25$ °C; $I_T = 3000$ A	max. 1,25	V
$V_{T(TO)}$	$T_{vj} = 125$ °C	max. 0,88	V
$r_T$	$T_{vj} = 125$ °C	max. 0,124	mΩ
$I_{DD}, I_{RD}$	$T_{vj} = 125$ °C; $V_{RD} = V_{RRM}, V_{DD} = V_{DRM}$	max. 100	mA
$t_{gd}$	$T_{vj} = 25$ °C; $I_G = 1$ A; $di_G/dt = 1$ A/μs	1	μs
$t_{gr}$	$V_D = 0,67 * V_{DRM}$	2	μs
$(di/dt)_{cr}$	$T_{vj} = 125$ °C	max. 150	A/μs
$(dv/dt)_{cr}$	$T_{vj} = 125$ °C	max. 1000	V/μs
$t_q$	$T_{vj} = 125$ °C	200 ... 300	μs
$I_H$	$T_{vj} = 25$ °C; typ. / max.	500 / 1000	mA
$I_L$	$T_{vj} = 25$ °C; typ. / max.	2000 / 5000	mA
$V_{GT}$	$T_{vj} = 25$ °C; d.c.	min. 3	V
$I_{GT}$	$T_{vj} = 25$ °C; d.c.	min. 300	mA
$V_{GD}$	$T_{vj} = 125$ °C; d.c.	max. 0,25	V
$I_{GD}$	$T_{vj} = 125$ °C; d.c.	max. 10	mA
$R_{th(j-c)}$	cont.; DSC	0,015	K/W
$R_{th(j-c)}$	sin. 180; DSC / SSC	0,0155 / 0,033	K/W
$R_{th(j-c)}$	rec. 120; DSC / SSC	0,0165 / 0,0345	K/W
$R_{th(c-s)}$	DSC / SSC	0,003 / 0,006	K/W
$T_{vj}$		- 40 ... + 125	°C
$T_{stg}$		- 40 ... + 130	°C
$V_{isol}$		-	V~
F	mounting force	27 ... 34	kN
a			m/s <sup>2</sup>
m	approx.	1000	g
Case		B 19	



SKT

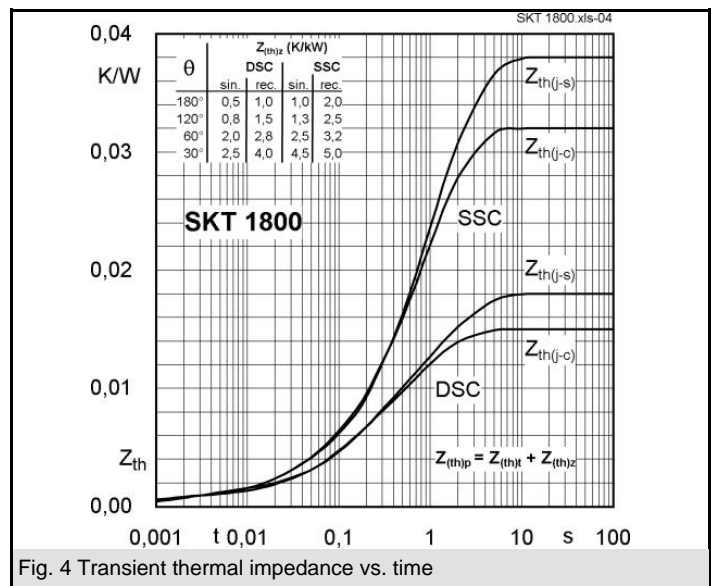
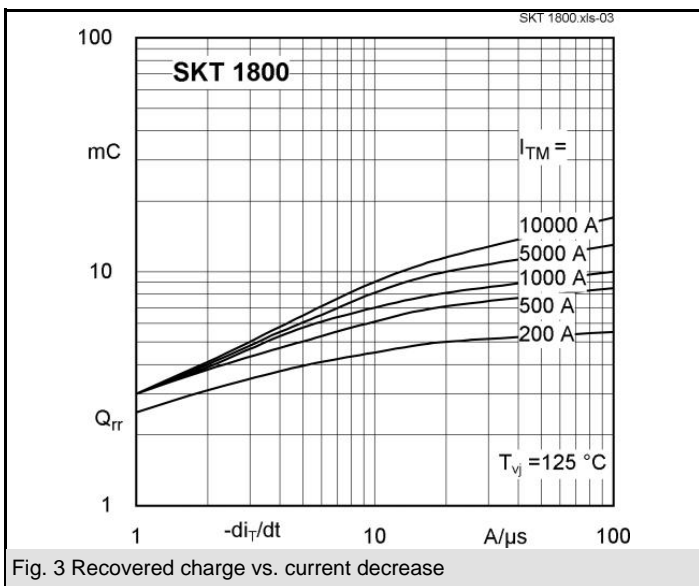
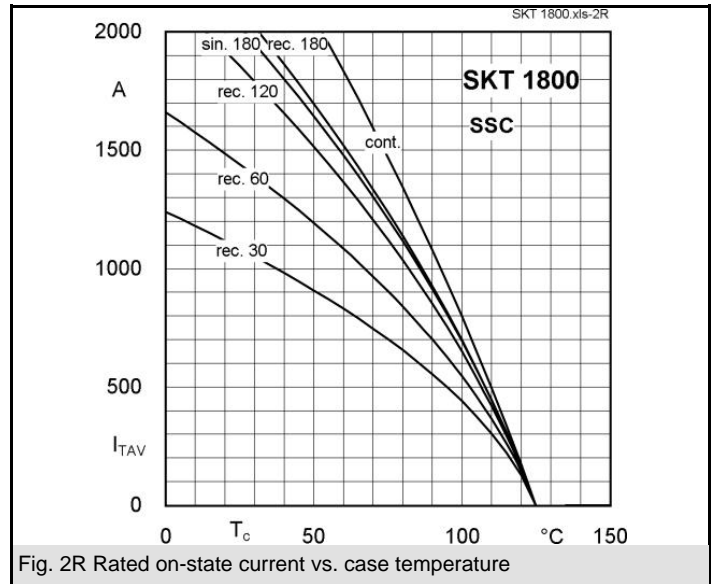
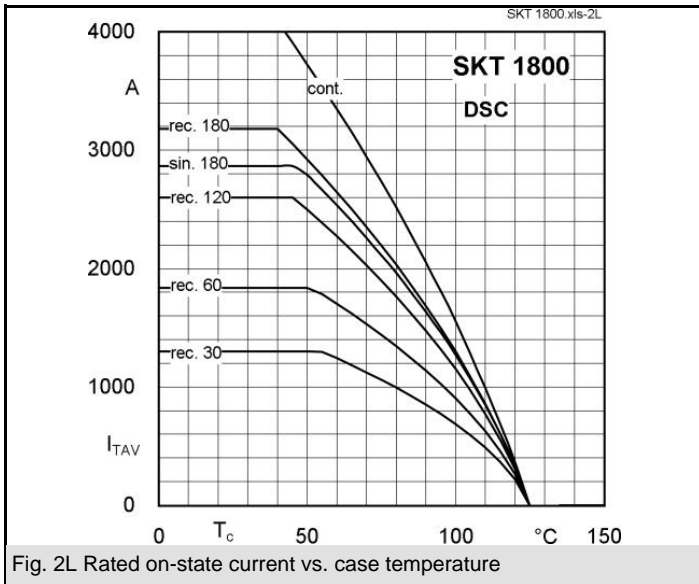
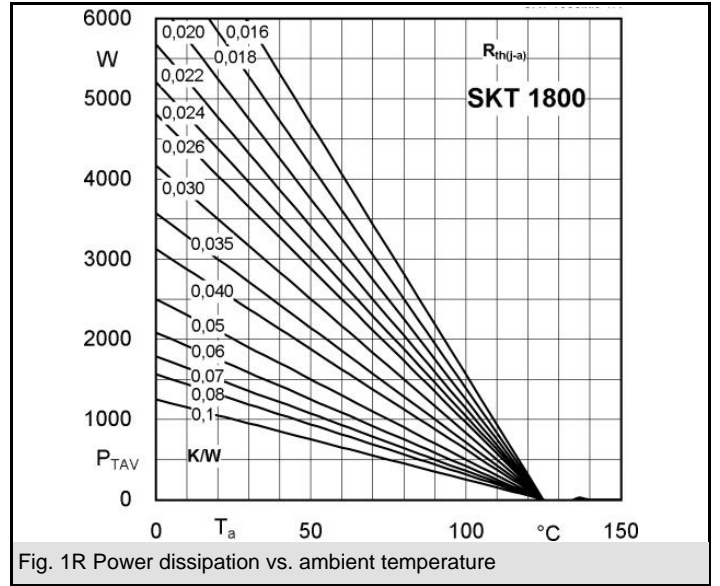
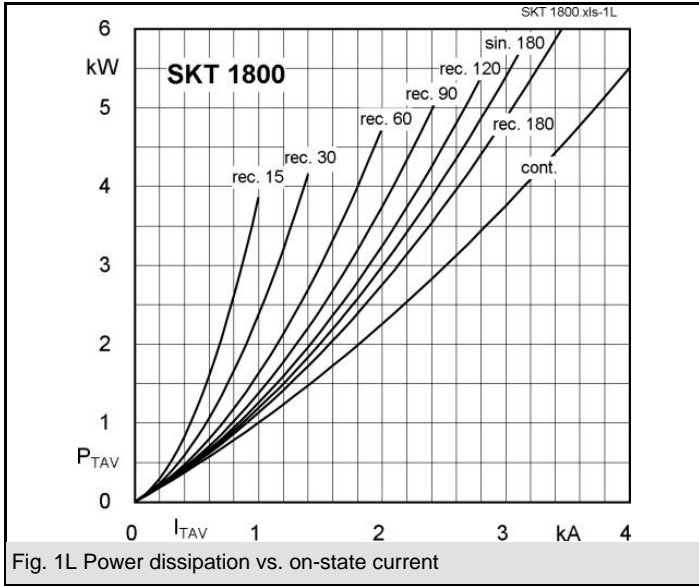

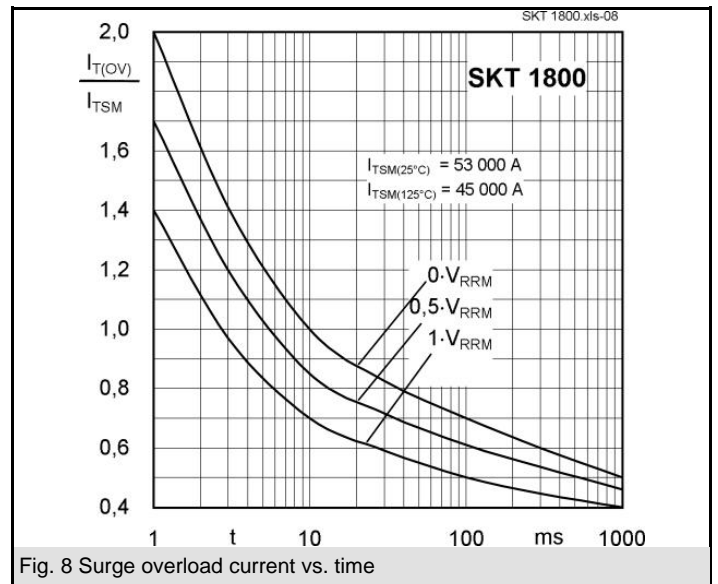
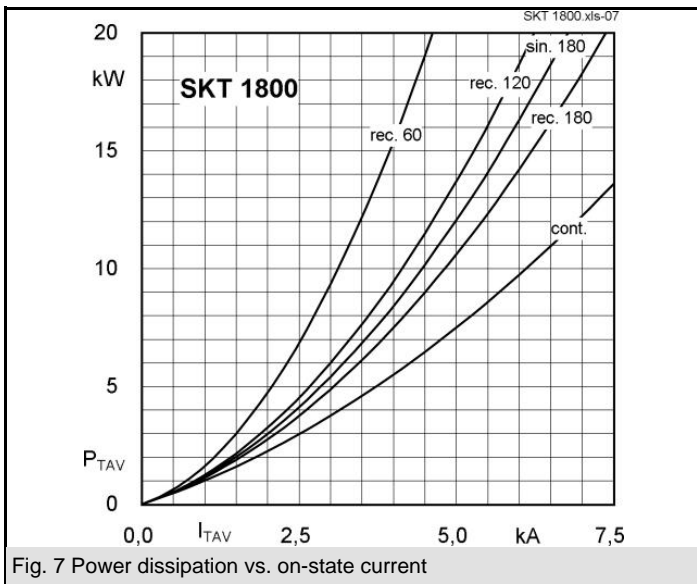
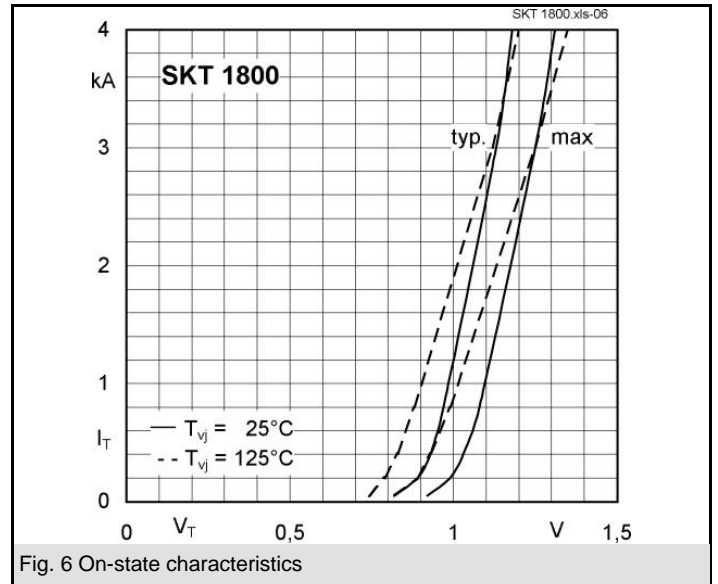
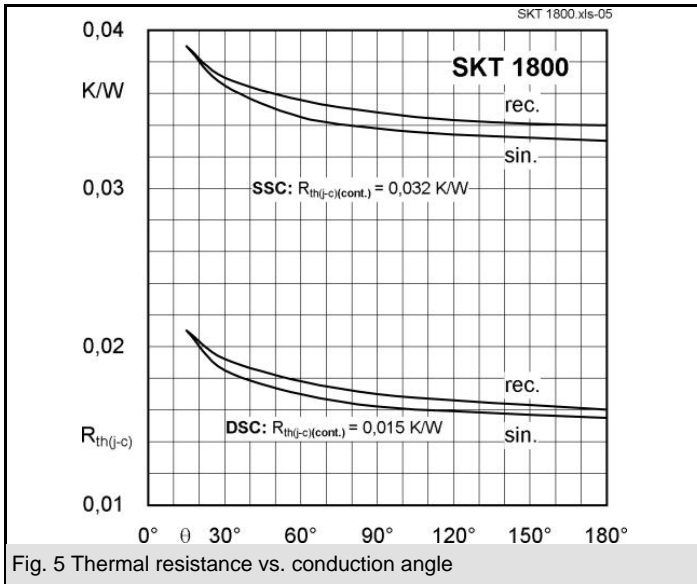

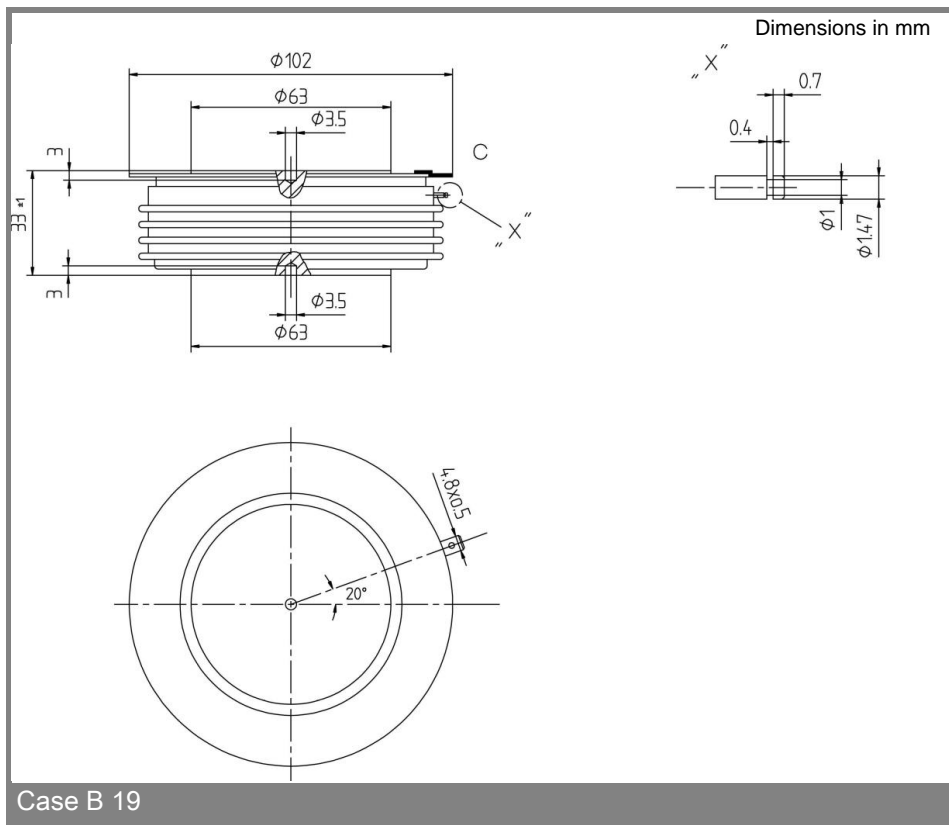
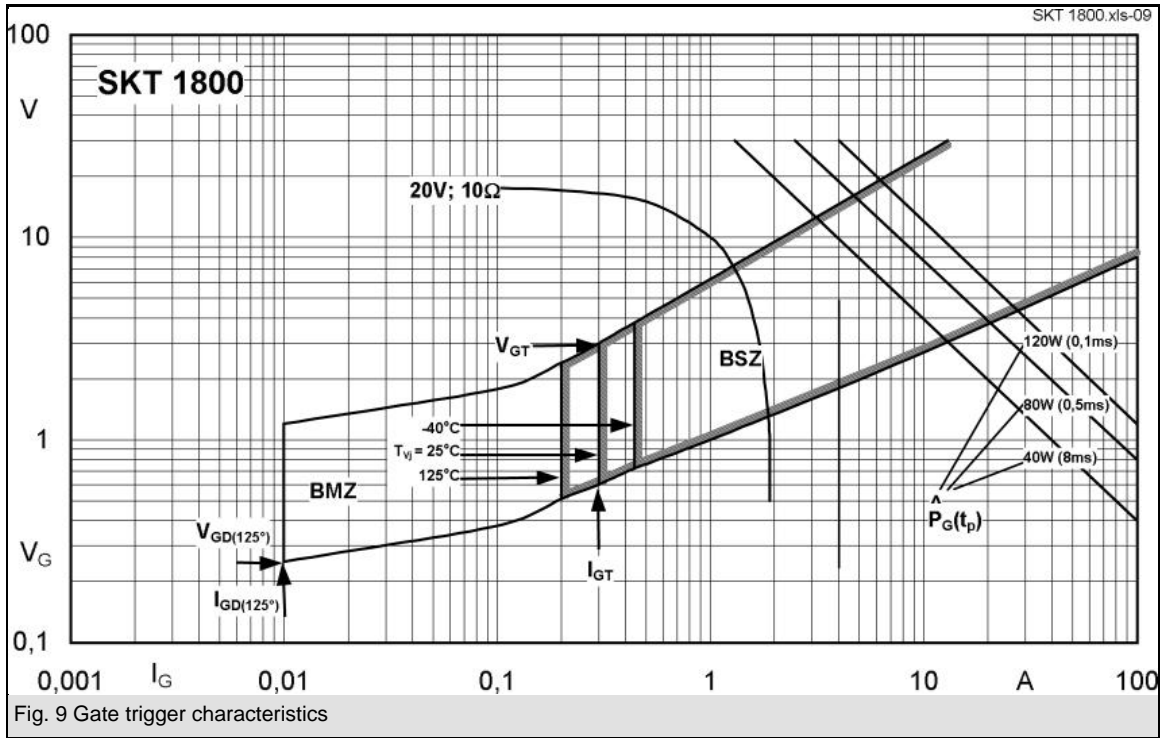

\* The specifications of our components may not be considered as an assurance of component characteristics. Components have to be tested for the respective application. Adjustments may be necessary. The use of SEMIKRON products in life support appliances and systems is subject to prior specification and written approval by SEMIKRON. We therefore strongly recommend prior consultation of our personal.