



Capsule Thyristor

Line Thyristor

SKT 240

Features

- Hermetic metal case with ceramic insulator
- Capsule package for double sided cooling
- Shallow design with single sided cooling
- International standard case
- Off-state and reverse voltages up to 1800 V

Typical Applications

- DC motor control (e. g. for machine tools)
- Controlled rectifiers (e. g. for battery charging)
- AC controllers (e. g. for temperature control)
- Recommended snubber network e. g. for $V_{VRMS} \leq 400$ V:
 $R = 33 \Omega / 32$ W, $C = 0,47 \mu F$

V_{RSM} V	V_{RRM}, V_{DRM} V	$I_{TRMS} = 600$ A (maximum value for continuous operation) $I_{TAV} = 240$ A (sin. 180; DSC; $T_c = 93$ °C)	
500	400	SKT 240/04E	
900	800	SKT 240/08E	
1300	1200	SKT 240/12E	
1500	1400	SKT 240/14E	
1700	1600	SKT 240/16E	
1900	1800	SKT 240/18E	

Symbol	Conditions	Values	Units
I_{TAV}	sin. 180; $T_c = 100$ (85) °C;	204 (282)	A
I_D	2 x P8/180; $T_a = 45$ °C; B2 / B6	275 / 390	A
	2 x P8/180F; $T_a = 35$ °C; B2 / B6	540 / 750	A
I_{RMS}	2 x P8/180; $T_a = 45$ °C; W1C	300	A
I_{TSM}	$T_{vj} = 25$ °C; 10 ms	5000	A
	$T_{vj} = 125$ °C; 10 ms	4500	A
i^2t	$T_{vj} = 25$ °C; 8,3 ... 10 ms	125000	A ² s
	$T_{vj} = 125$ °C; 8,3 ... 10 ms	101000	A ² s
V_T	$T_{vj} = 25$ °C; $I_T = 1000$ A	max. 2,3	V
$V_{T(TO)}$	$T_{vj} = 125$ °C	max. 1	V
r_T	$T_{vj} = 125$ °C	max. 1,4	mΩ
I_{DD}, I_{RD}	$T_{vj} = 125$ °C; $V_{RD} = V_{RRM}, V_{DD} = V_{DRM}$	max. 40	mA
t_{gd}	$T_{vj} = 25$ °C; $I_G = 1$ A; $di_G/dt = 1$ A/μs	1	μs
t_{gr}	$V_D = 0,67 * V_{DRM}$	2	μs
$(di/dt)_{cr}$	$T_{vj} = 125$ °C	max. 125	A/μs
$(dv/dt)_{cr}$	$T_{vj} = 125$ °C	max. 1000	V/μs
t_q	$T_{vj} = 125$ °C,	50 ... 150	μs
I_H	$T_{vj} = 25$ °C; typ. / max.	150 / 400	mA
I_L	$T_{vj} = 25$ °C; typ. / max.	300 / 1000	mA
V_{GT}	$T_{vj} = 25$ °C; d.c.	min. 2	V
I_{GT}	$T_{vj} = 25$ °C; d.c.	min. 150	mA
V_{GD}	$T_{vj} = 125$ °C; d.c.	max. 0,25	V
I_{GD}	$T_{vj} = 125$ °C; d.c.	max. 10	mA
$R_{th(j-c)}$	cont.; DSC	0,07	K/W
	sin. 180; DSC / SSC	0,072 / 0,151	K/W
	rec. 120; DSC / SSC	0,08 / 0,168	K/W
$R_{th(c-s)}$	DSC / SSC	0,02 / 0,04	K/W
T_{vj}		- 40 ... + 125	°C
T_{stg}		- 40 ... + 130	°C
V_{isol}		-	V~
F	mounting force	4 ... 5	kN
a			m/s ²
m	approx.	55	g
Case		B 8	



SKT

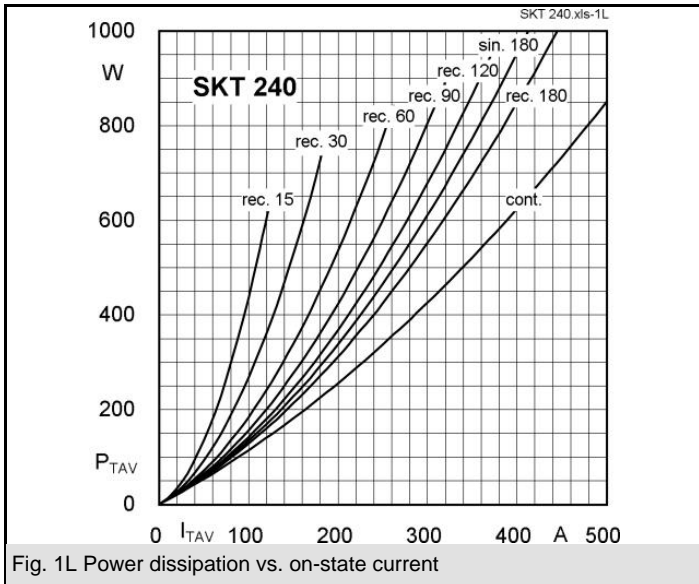

Fig. 1L Power dissipation vs. on-state current

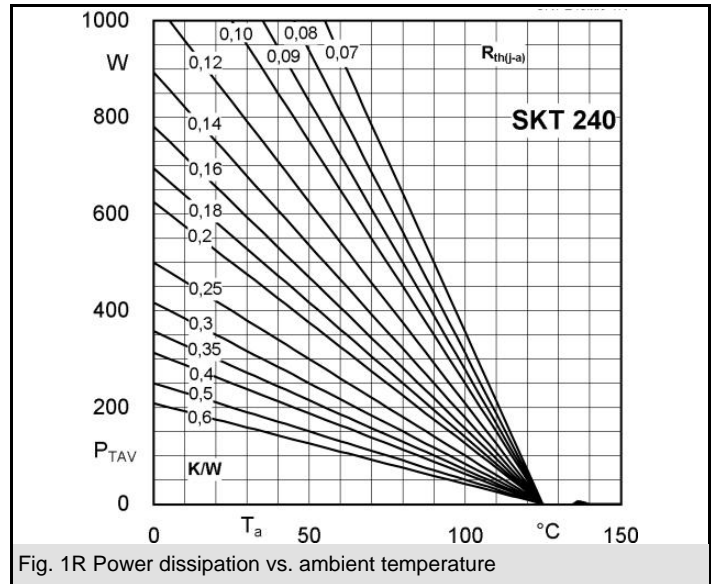

Fig. 1R Power dissipation vs. ambient temperature

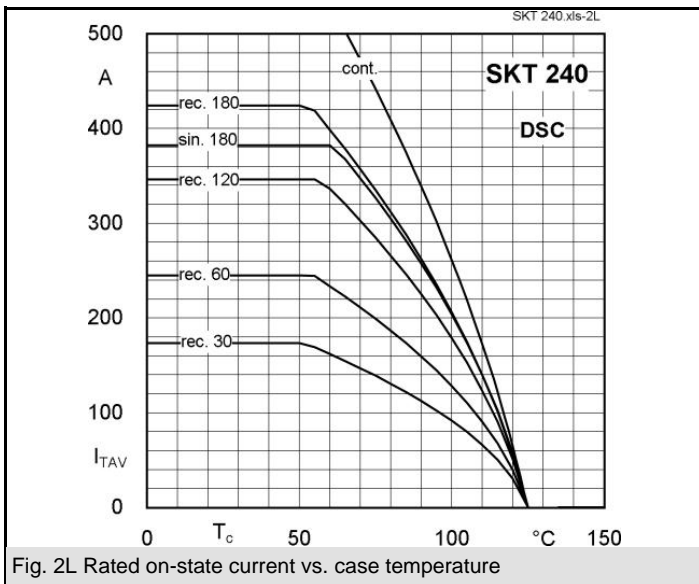

Fig. 2L Rated on-state current vs. case temperature

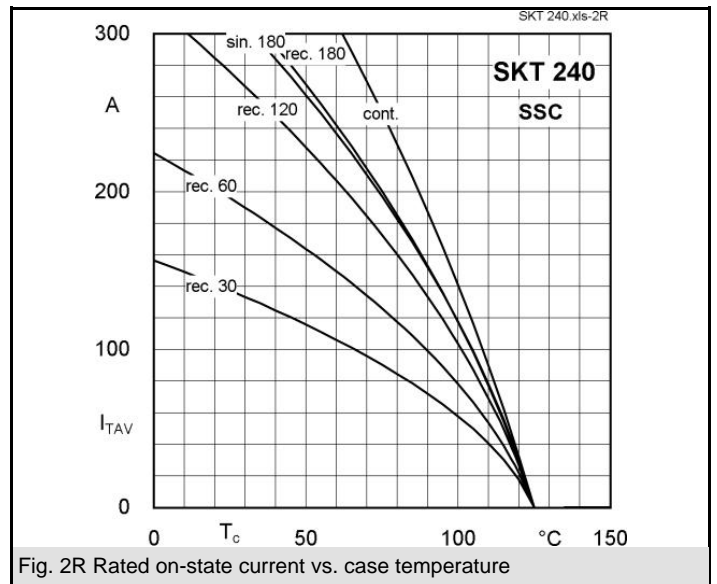

Fig. 2R Rated on-state current vs. case temperature

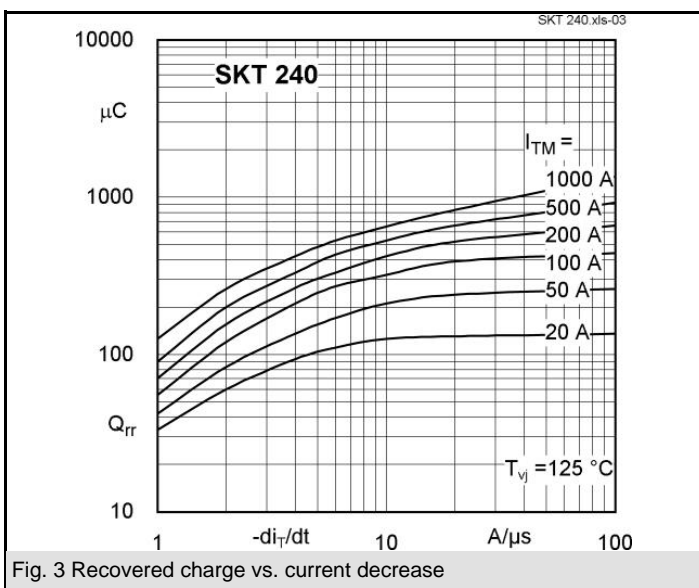

Fig. 3 Recovered charge vs. current decrease

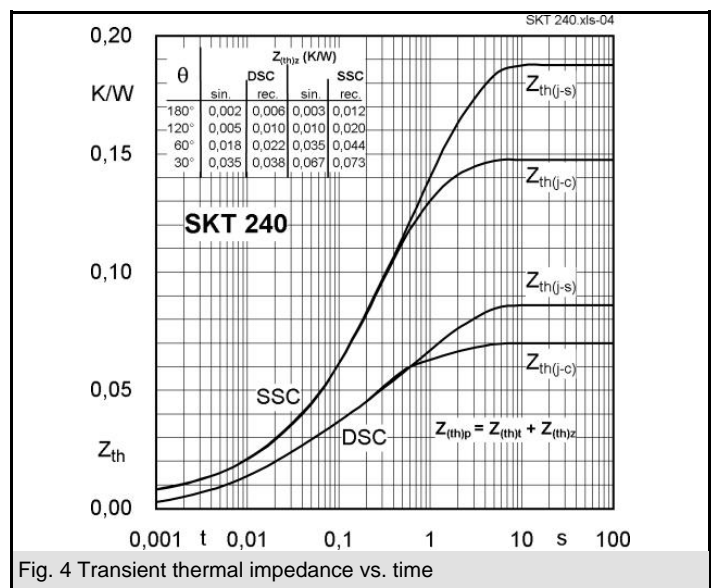
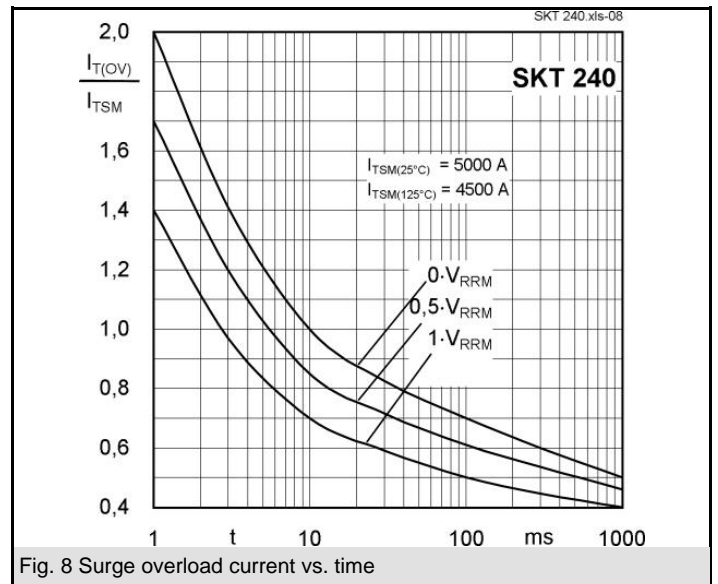
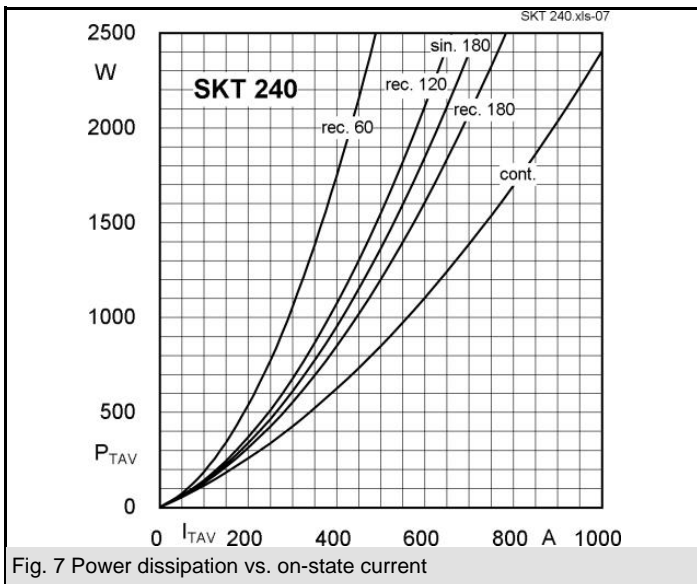
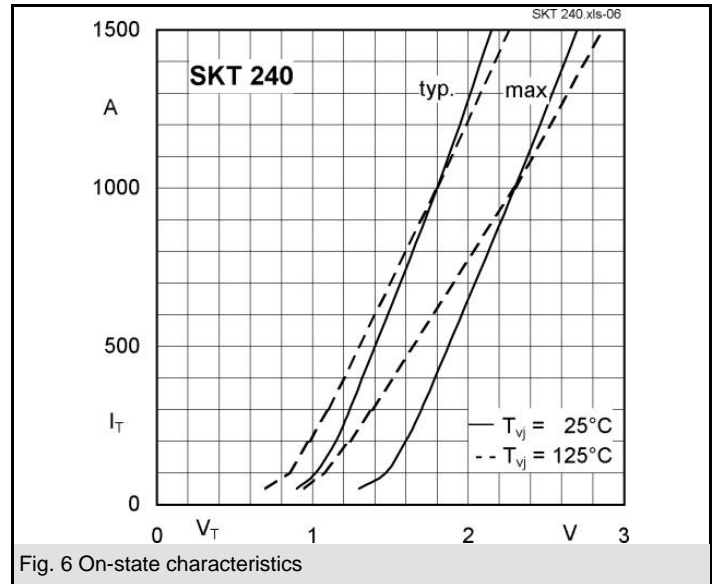
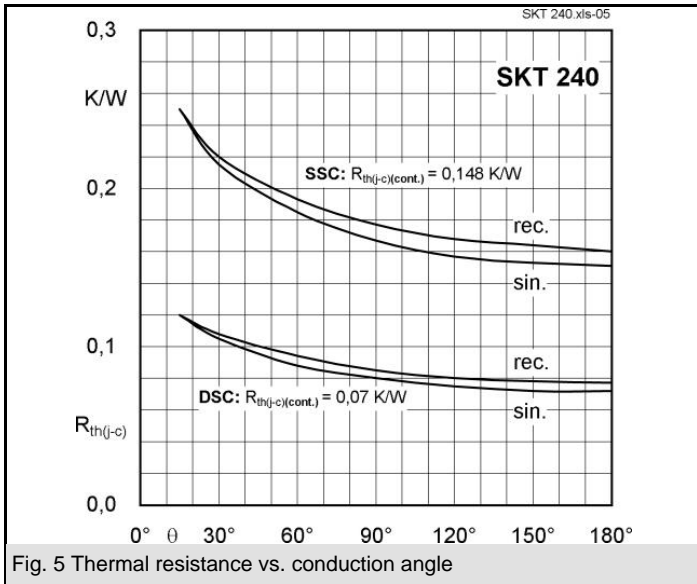
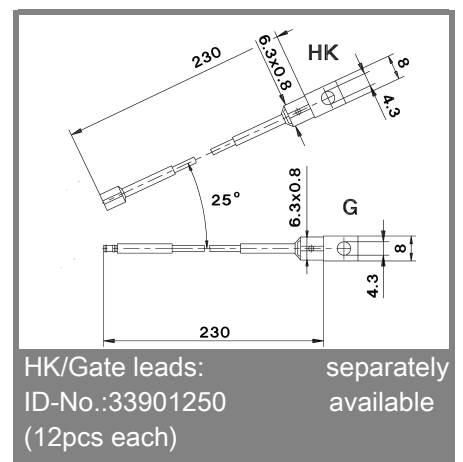
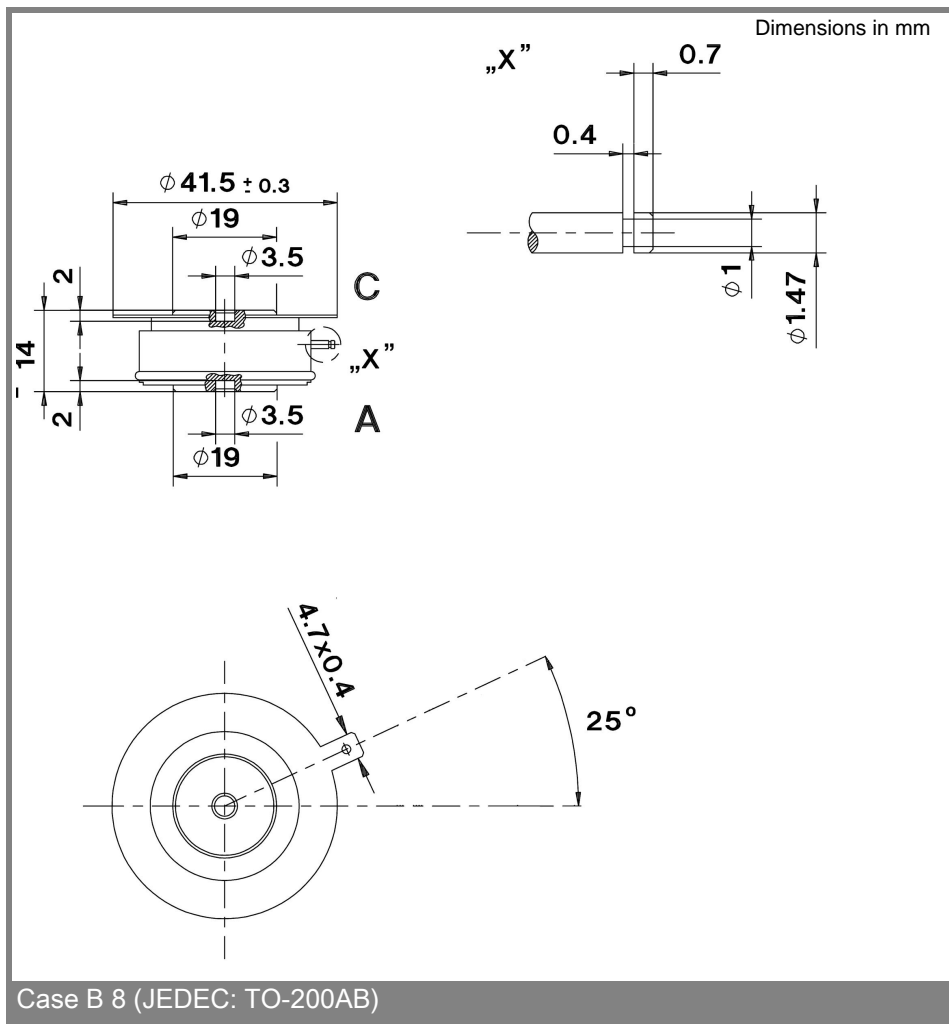
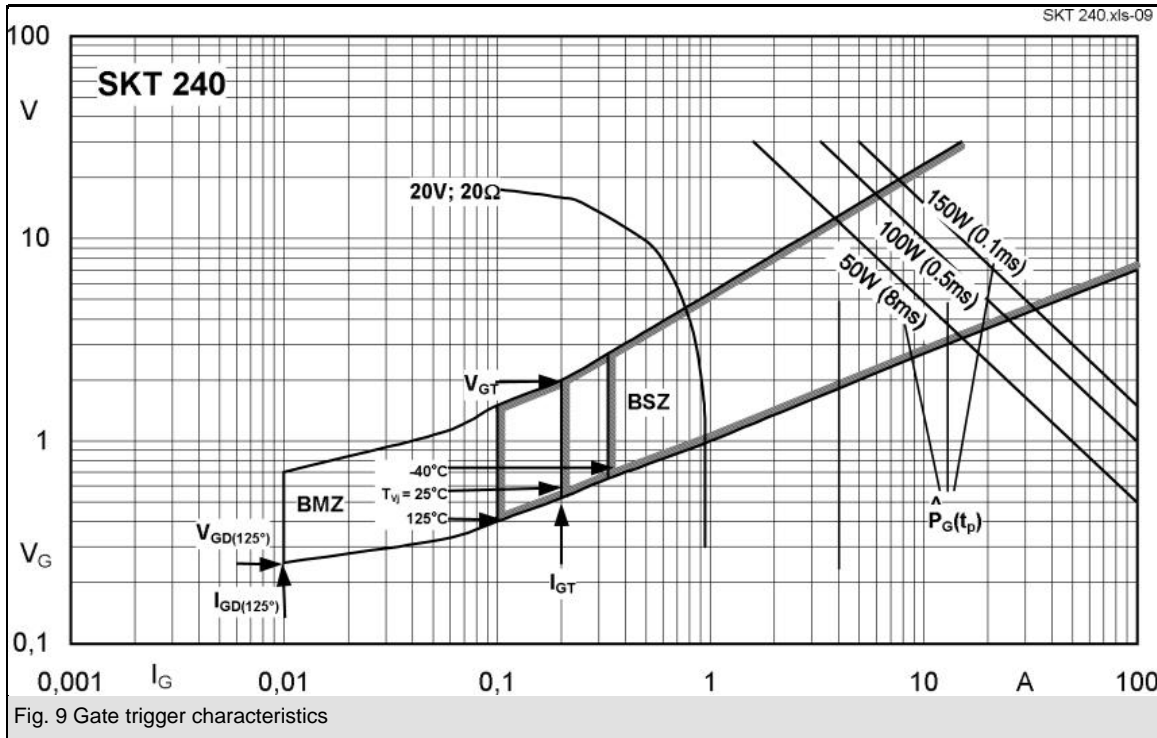

Fig. 4 Transient thermal impedance vs. time





This technical information specifies semiconductor devices but promises no characteristics. No warranty or guarantee expressed or implied is made regarding delivery, performance or suitability.