



# WESTCODE SEMICONDUCTORS

 Technical  
Publication

**TN450C**

 Issue 3  
July 1985

## Converter Grade Capsule Thyristor Type N450C

 1080 amperes average: up to 2400 volts  $V_{RRM}$ 

### Ratings (Maximum values at 125°C T<sub>j</sub> unless stated otherwise)

RATING	CONDITIONS	SYMBOL	
Average on-state current	Half sine wave $\left\{ \begin{array}{l} 55^\circ\text{C heatsink temperature} \\ \text{(double side cooled)} \\ 85^\circ\text{C heatsink temperature} \\ \text{(single side cooled)} \end{array} \right.$	$I_{T(AV)}$	1080A 454A
R.M.S. on-state current	25°C heatsink temperature, double side cooled	$I_{T(RMS)}$	2140A
Continuous on-state current	25°C heatsink temperature, double side cooled	$I_T$	1900A
Peak one-cycle surge (non-repetitive) on state current	10ms duration, 60% $V_{RRM}$ re-applied	$I_{TSM(1)}$	16000A
	10ms duration, $V_R \leq 10$ volts	$I_{TSM(2)}$	17600A
Maximum permissible surge energy	10ms duration, $V_R \leq 10$ volts	$I^2t(2)$	1550000A <sup>2</sup> s
	3ms duration, $V_R \leq 10$ volts	$I^2t$	1150000A <sup>2</sup> s
Peak forward gate current	Anode positive with respect to cathode	$I_{FGM}$	20A
Peak forward gate voltage	Anode positive with respect to cathode	$V_{FGM}$	22V
Peak reverse gate voltage		$V_{RGM}$	5V
Average gate power		$P_G$	4W
Peak gate power	100μs. pulse width	$P_{GM}$	120W
Rate of rise of off-state voltage	To 80% $V_{DRM}$ gate open-circuit	$dv/dt$	*200V/μs
Rate of rise of on-state current (repetitive)	$\left\{ \begin{array}{l} \text{Gate drive 20 volts, 20 ohms with } t_r \leq 1\mu\text{s.} \\ \text{Anode voltage } \leq 80\% V_{DRM} \end{array} \right.$	$di/dt(1)$	300A/μs
Rate of rise of on-state current (non-repetitive)		$di/dt(2)$	500A/μs
Operating temperature range		$T_{hs}$	-40 + 125°C
Storage temperature range		$T_{stg}$	-40 + 150°C

### Characteristics (Maximum values at 125°C T<sub>j</sub> unless stated otherwise)

CHARACTERISTIC	CONDITIONS	SYMBOL	
Peak on-state voltage	At 2300A, $I_{TM}$	$V_{TM}$	1.9V
Forward conduction threshold voltage		$V_O$	1.03V
Forward conduction slope resistance		$r$	0.38mΩ
Repetitive peak off-state current	At $V_{DRM}$	$I_{DRM}$	100mA
Repetitive peak reverse current	At $V_{RRM}$	$I_{RRM}$	100mA
Maximum gate current required to fire all devices	$\left. \begin{array}{l} V_A = 6V. I_A = 2A. \text{ at } 25^\circ\text{C } T_j \end{array} \right\}$	$I_{GT}$	300mA
Maximum gate voltage required to fire all devices		$V_{GT}$	3V
Maximum holding current		$I_H$	1A
Maximum gate voltage which will not trigger any device		$V_{GD}$	0.25V
Thermal resistance, junction to heatsink, for a device with a maximum forward volt drop characteristic	Double side cooled	$R_{th(j-hs)}$	0.03°C/W
	Single side cooled		0.06°C/W

VOLTAGE CODE		H14	H16	H18	H20	H22	H24		
Repetitive peak voltages	$V_{RRM}$ $V_{DRM}$	1400	1600	1800	2000	2200	2400		
Non-repetitive peak off-state voltage	$V_{DSM}$								
Non-repetitive peak reverse blocking voltage	$V_{RSM}$	1500	1700	1900	2100	2300	2500		

### Ordering Information (Please quote device code as explained below – 8 digits)

N 4 5 0 C	● ● ●	Typical code: N450CH24 = 2400 $V_{RRM}$ 2400V <sub>DRM</sub> , 200 V/μs. dv/dt to 80% $V_{DRM}$
	Voltage code (see ratings)	

\* Other values of dv/dt may be available.

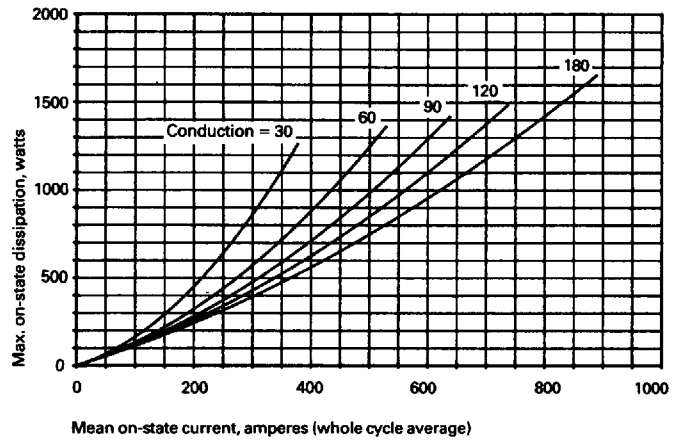
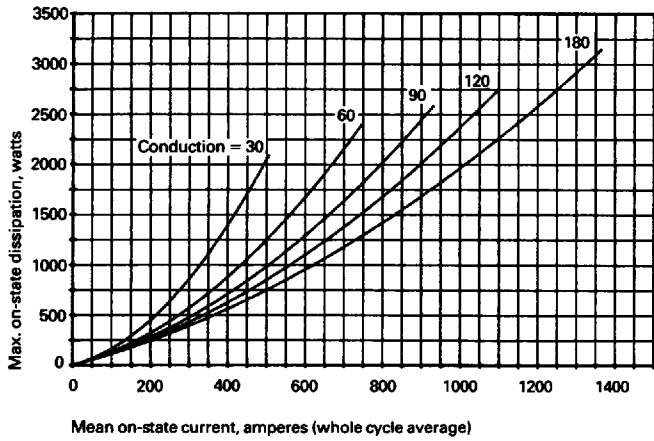
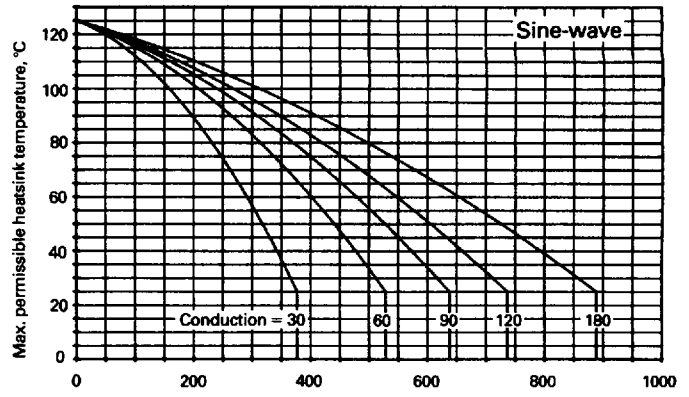
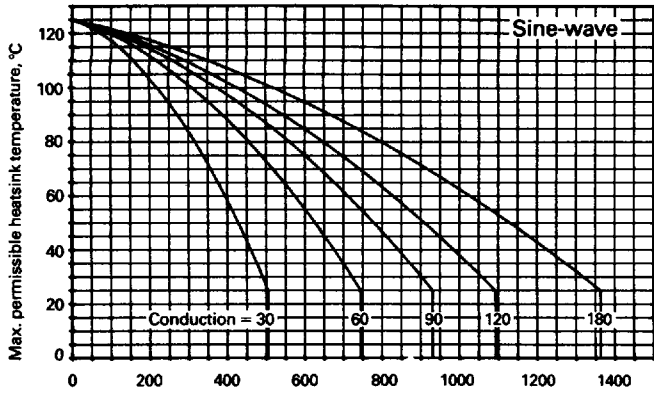

Figure 1 Dissipation and heatsink temperature v. current (Double side cooled)

Figure 2 Dissipation and heatsink temperature v. current (Single side cooled)

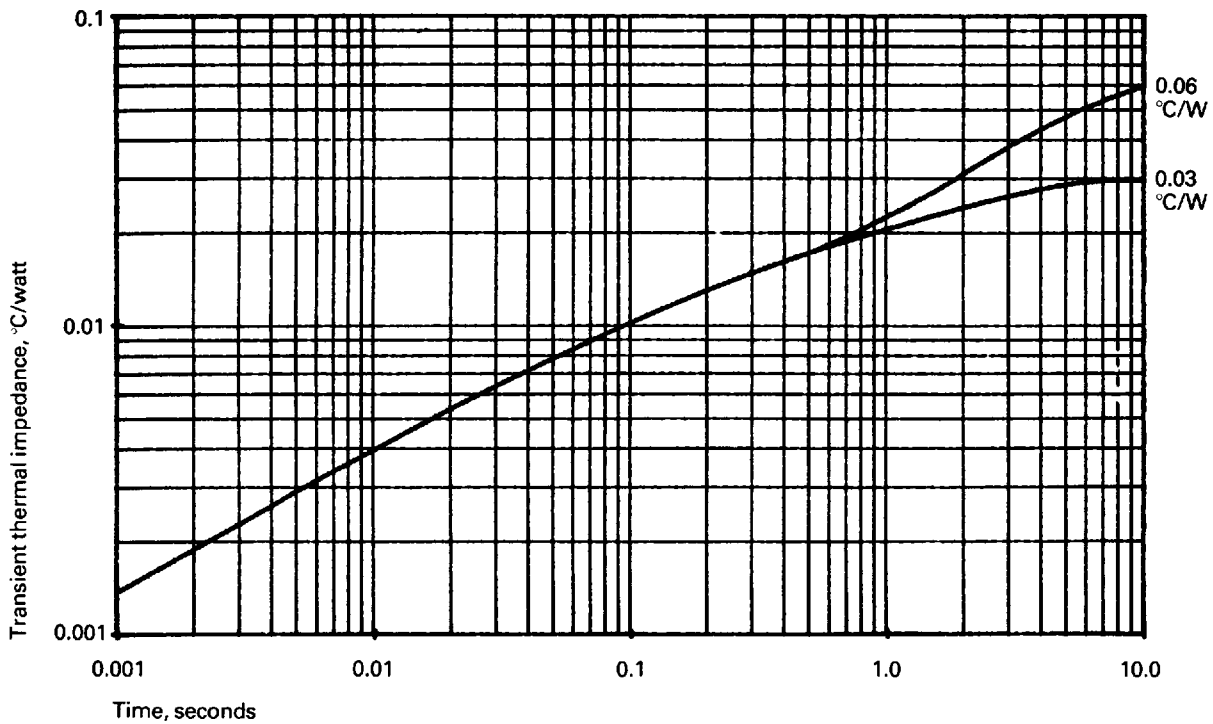
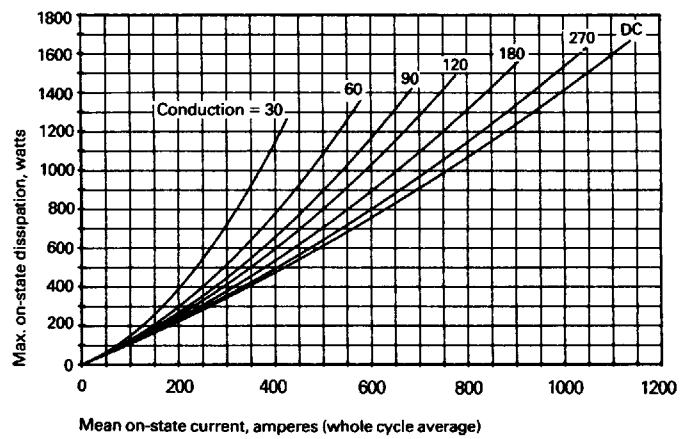
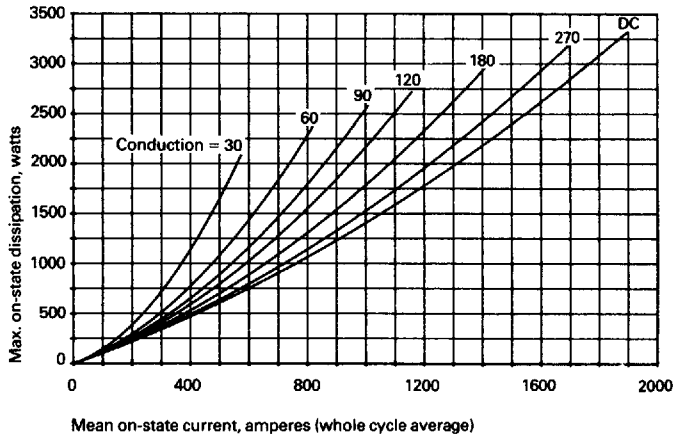
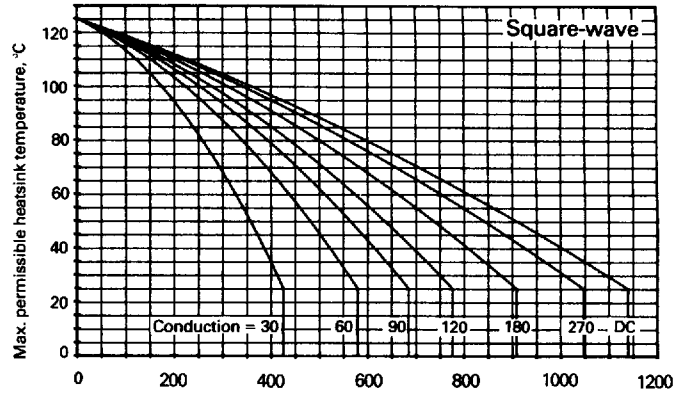
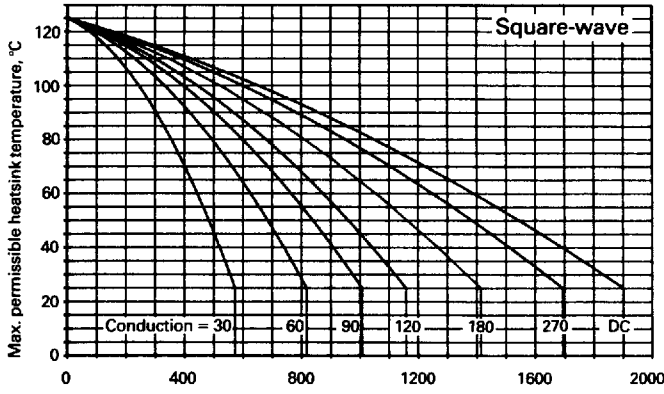
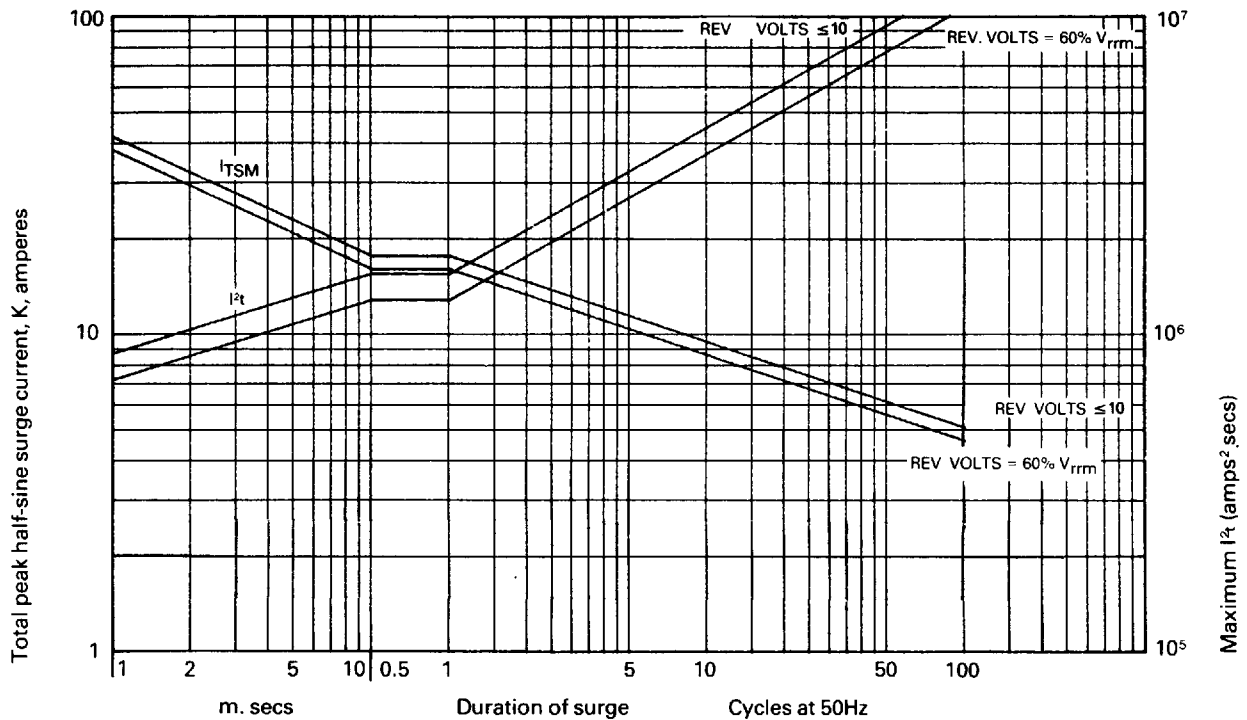

Figure 3 Junction to heatsink thermal impedance



**Figure 4 Dissipation and heatsink temperature v. current (Double side cooled)**

**Figure 5 Dissipation and heatsink temperature v. current (Single side cooled)**



**Figure 6 Max. non-repetitive surge current at initial junction temperature 125°C.**

(gate may temporarily lose control of firing angle)

Note: This rating must not be interpreted as an intermittent rating

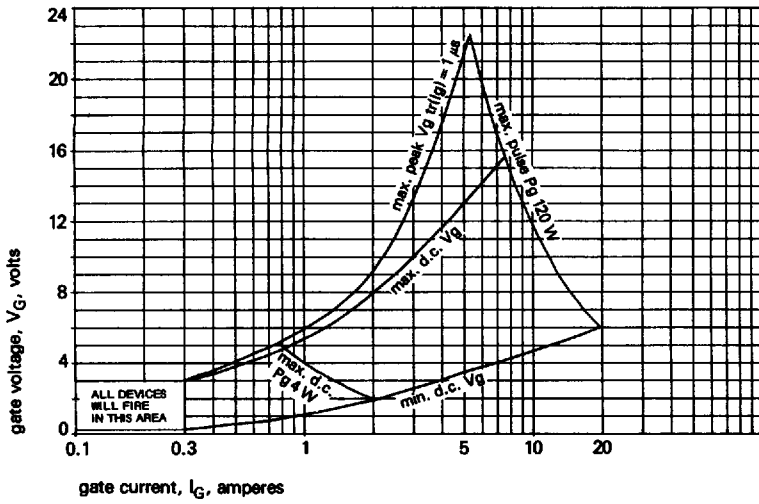

Figure 7 Gate characteristics at 25°C junction temperature

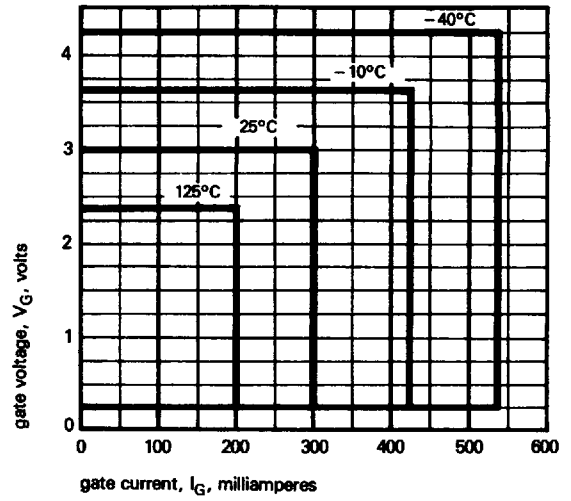

Figure 8 Gate triggering characteristics  
Trigger points of all thyristors lie within the areas shown

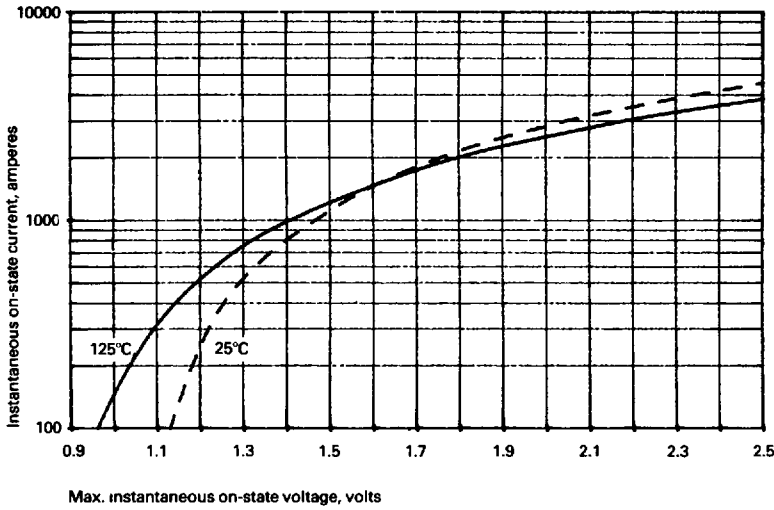
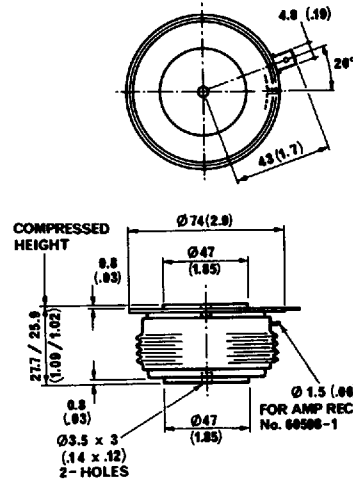

Figure 9 Limit on-state characteristic



Dimensions in mm (inches)  
Mounting force: 1900-2600 Kgf  
Weight: 510 grams

In the interest of product improvement, Westcode reserves the right to change specifications at any time without notice.

**WESTCODE SEMICONDUCTORS LTD.**

P.O. Box 57 Chippenham Wiltshire SN15 1JL England  
Telephone Chippenham (0249) 654141 Telex 44751

**HAWKER SIDDELEY**  
**Westinghouse Brake and Signal Co. Ltd.**

