

## Thyristors

### SKT 250 SKT 300



#### Features

- Hermetic metal cases with ceramic insulators
- Threaded studs ISO M24 x 1,5 or UNF 3/4-16
- High  $i^2t$  and  $I_{TSM}$  values for easy fusing
- International standard cases

#### Typical Applications

- DC motor control (e. g. for machine tools)
- Controlled rectifiers (e. g. for battery charging)
- AC controllers (e. g. for temperature control)

$V_{RSM}$	$V_{RRM}$ $V_{DRM}$	$(\frac{dv}{dt})_{cr}$	$I_{TRMS}$ (maximum values for continuous operation)	
			450 A	550 A
V	V	V/ $\mu$ s	$I_{TAV}$ (sin. 180; $T_{case} = \dots$ °C)	
			285 A (77 °C)	350 A (85 °C)
500	400	500	<b>SKT 250/04 D</b>	<b>SKT 300/04 D</b>
900	800	500	<b>SKT 250/08 D</b>	<b>SKT 300/08 D*</b>
1300	1200	1000	<b>SKT 250/12 E</b>	<b>SKT 300/12 E*</b>
1500	1400	1000	<b>SKT 250/14 E</b>	<b>SKT 300/14 E*</b>
1700	1600	1000	<b>SKT 250/16 E</b>	<b>SKT 300/16 E*</b>

Symbol	Conditions	SKT 250	SKT 300	Units
$I_{TAV}$	sin. 180; ( $T_{case} = \dots$ )	250 (85 °C)	300 (93 °C)	A
$I_{TSM}$	$T_{vj} = 25$ °C; 10 ms $T_{vj} = 130$ °C; 10 ms	7000 6000	11 000 10 000	A A
$i^2t$	$T_{vj} = 25$ °C; 8,35 ... 10 ms $T_{vj} = 130$ °C; 8,35 ... 10 ms	245 000 180 000	600 000 500 000	$A^2s$ $A^2s$
$t_{gd}$	$T_{vj} = 25$ °C; $I_G = 1$ A; $di_G/dt = 1$ A/ $\mu$ s	typ. 1		$\mu$ s
$t_{gr}$	$V_D = 0,67 \cdot V_{DRM}$	typ. 2		$\mu$ s
$(di/dt)_{cr}$	$f = 50 \dots 60$ Hz	100		A/ $\mu$ s
$I_H$	$T_{vj} = 25$ °C;	typ. 150; max. 250		mA
$I_L$	$T_{vj} = 25$ °C; $R_G = 33$ $\Omega$	typ. 300; max. 600		mA
$t_q$	$T_{vj} = 130$ °C; typ.	50 ... 150		$\mu$ s
$V_T$	$T_{vj} = 25$ °C; $I_T = 800$ A; max.	1,65	1,45	V
$V_{T(TO)}$	$T_{vj} = 130$ °C	1,0	0,9	V
$r_T$	$T_{vj} = 130$ °C	0,7	0,5	m $\Omega$
$I_{DD}, I_{RD}$	$T_{vj} = 130$ °C; $V_{DD} = V_{DRM}$ $V_{RD} = V_{RRM}$	50	50	mA
$V_{GT}$	$T_{vj} = 25$ °C	3		V
$I_{GT}$	$T_{vj} = 25$ °C	200		mA
$V_{GD}$	$T_{vj} = 130$ °C	0,25		V
$I_{GD}$	$T_{vj} = 130$ °C	10		mA
$R_{thjc}$	cont.	0,110	0,090	°C/W
	sin. 180	0,123	0,096	°C/W
	rec. 120	0,137	0,101	°C/W
$R_{thch}$		0,015		°C/W
$T_{vj}$		- 40 ... +130		°C
$T_{stg}$		- 55 ... +150		°C
M	SI units	60 (UNF: 30)		Nm
	US units	530 (UNF: 265)		lb. in.
a		5 · 9,81		m/s <sup>2</sup>
w		450		g
Case		B 7		

\* available with UNF thread 3/4-16 UNF2A, e.g. SKT 300/08 D UNF

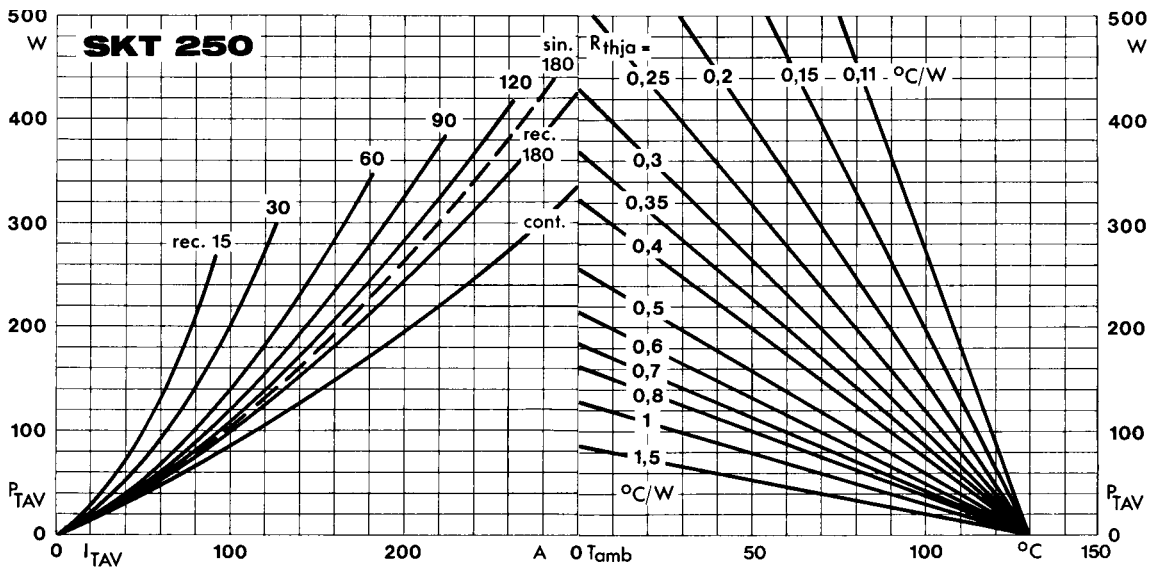

Fig. 1 a Power dissipation vs. on-state current and ambient temperature

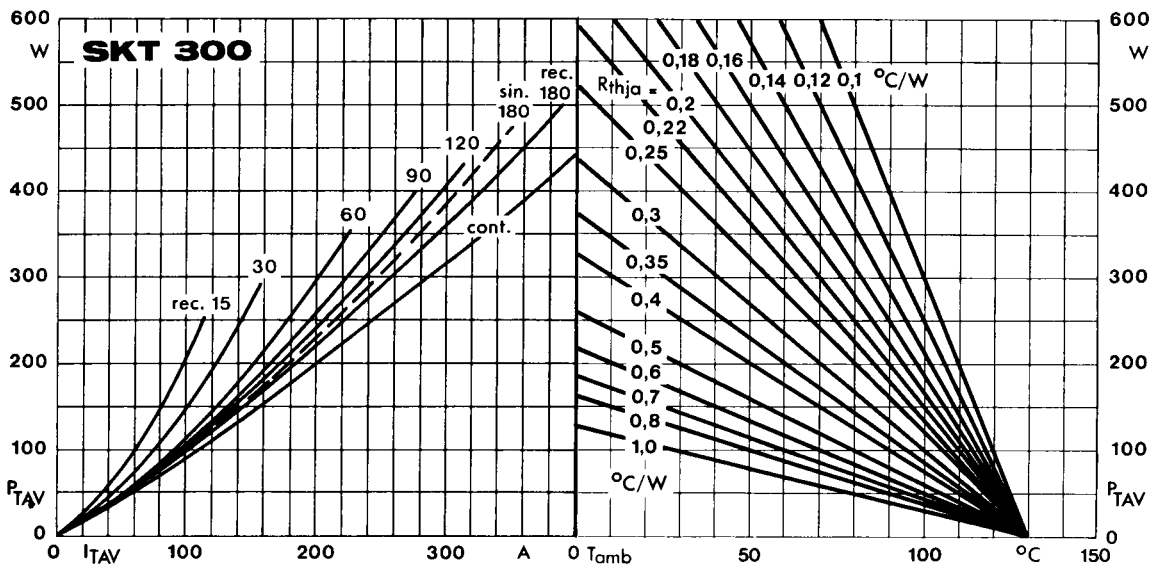

Fig. 1 b Power dissipation vs. on-state current and ambient temperature

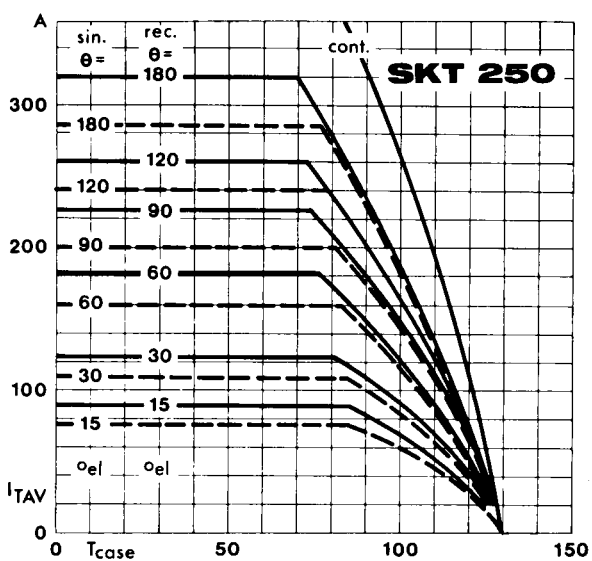

Fig. 2 a Rated on-state current vs. case temperature

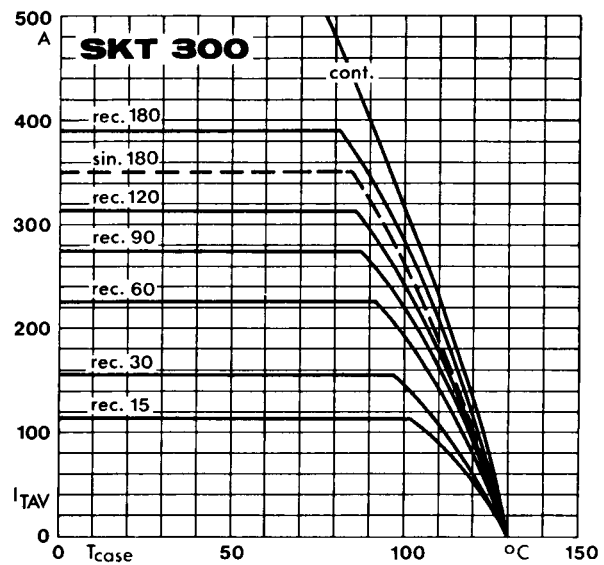

Fig. 2 b Rated on-state current vs. case temperature

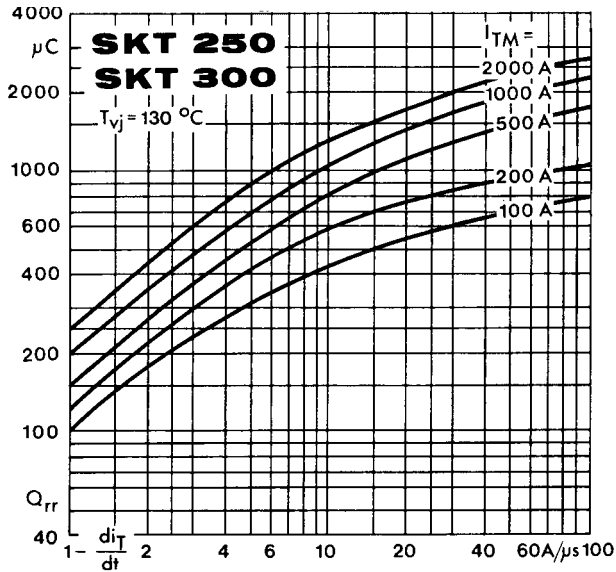

Fig. 3 Recovered charge vs. current decrease

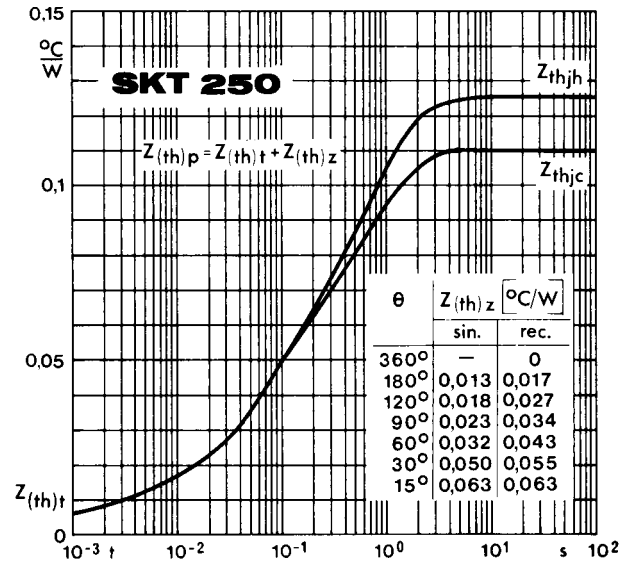

Fig. 4 a Transient thermal impedance vs. time

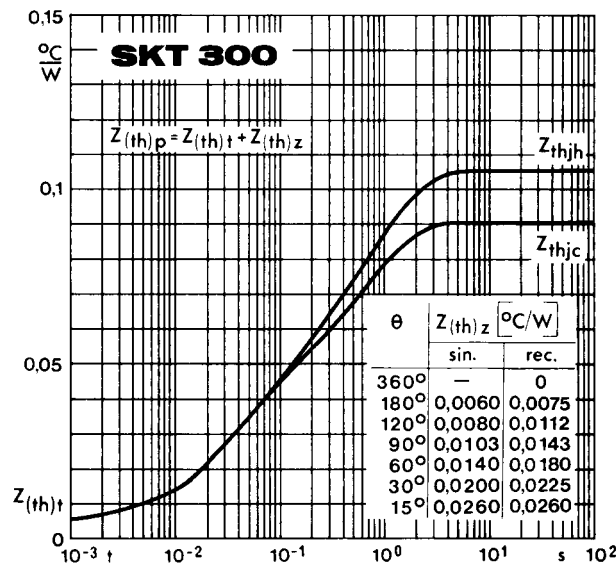

Fig. 4 b Transient thermal impedance vs. time

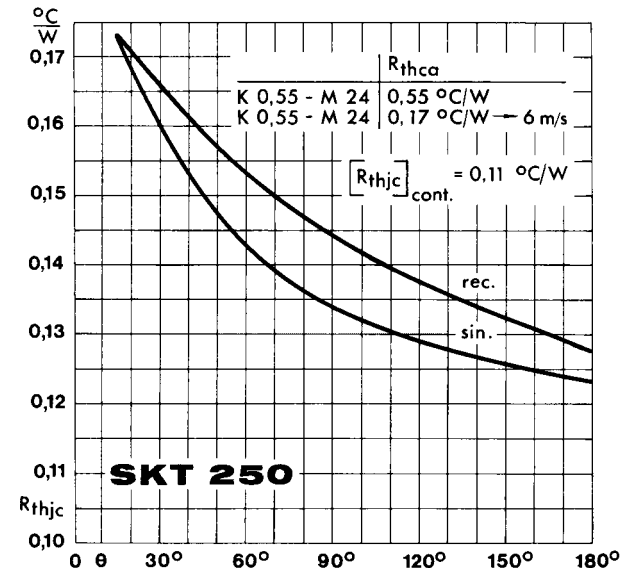

Fig. 5 a Thermal resistance vs. conduction angle

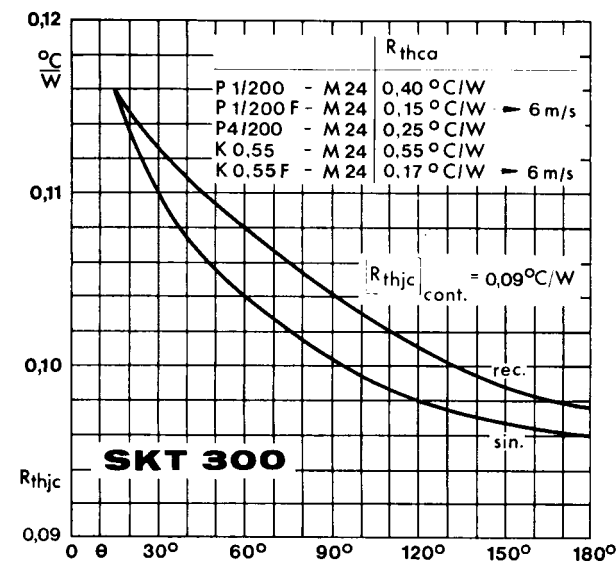

Fig. 5 b Thermal resistance vs. conduction angle

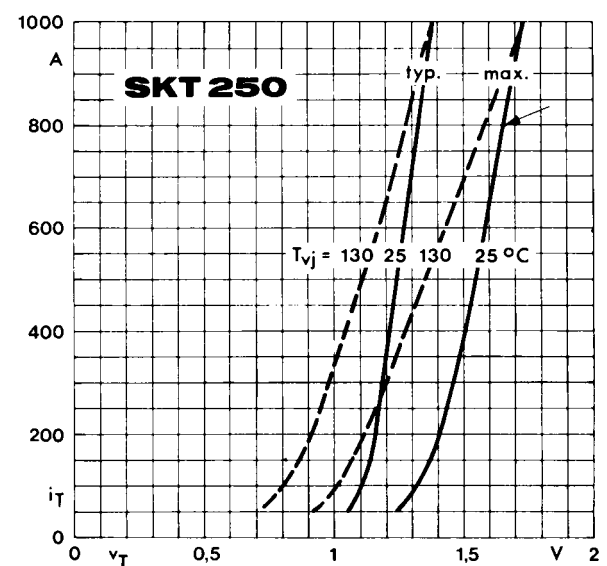

Fig. 6 a On-state characteristics

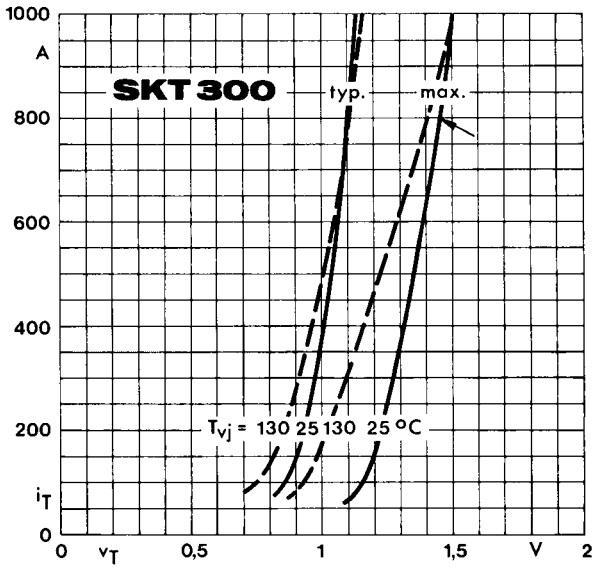

Fig. 6 b On-state characteristics

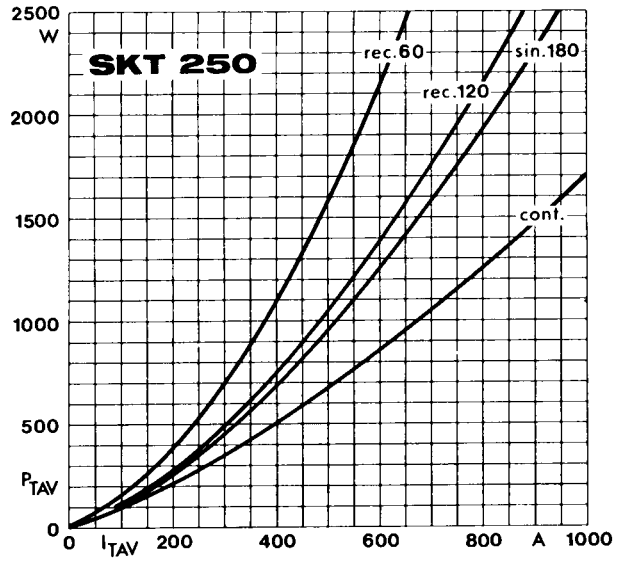

Fig. 7 a Power dissipation vs. on-state current

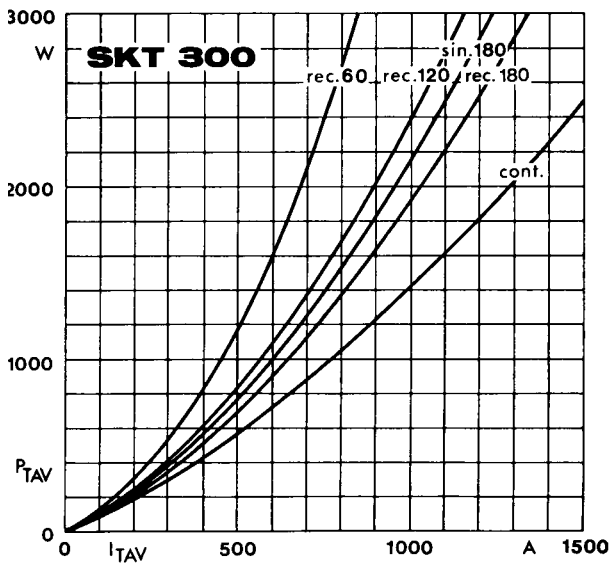

Fig. 7 b Power dissipation vs. on-state current

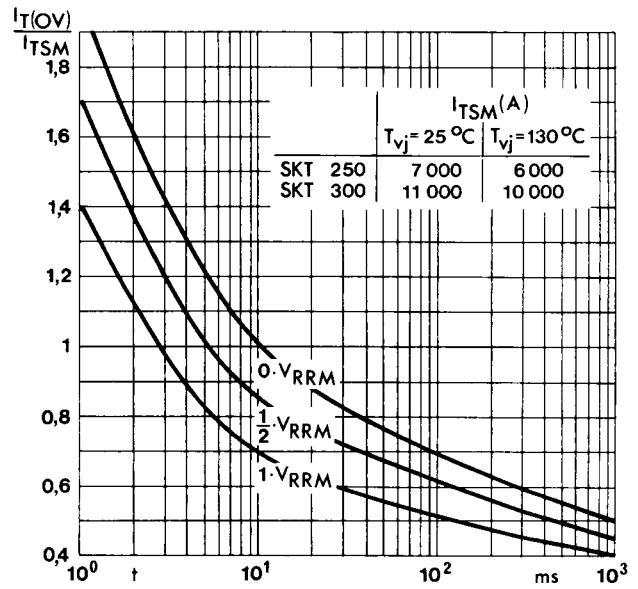

Fig. 8 Surge overload current vs. time

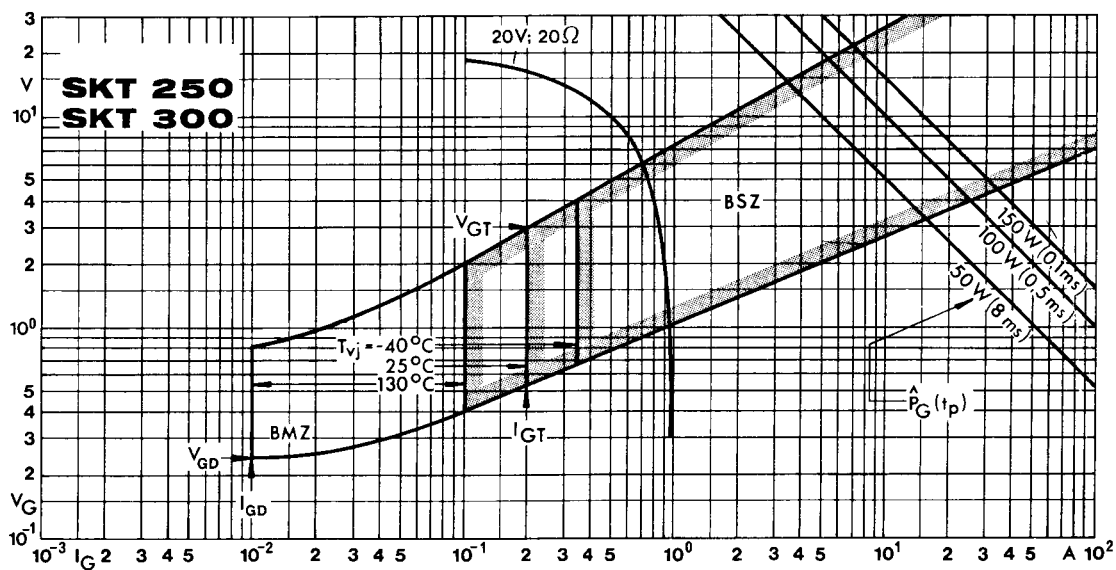

Fig. 9 Gate trigger characteristics

**SKT 250**  
**SKT 300**

Case B 7

IEC-Publ. 191-2: A 29 MA

DIN 41893: (207 B 4)

JEDEC: TO-209 AD (TO-118)

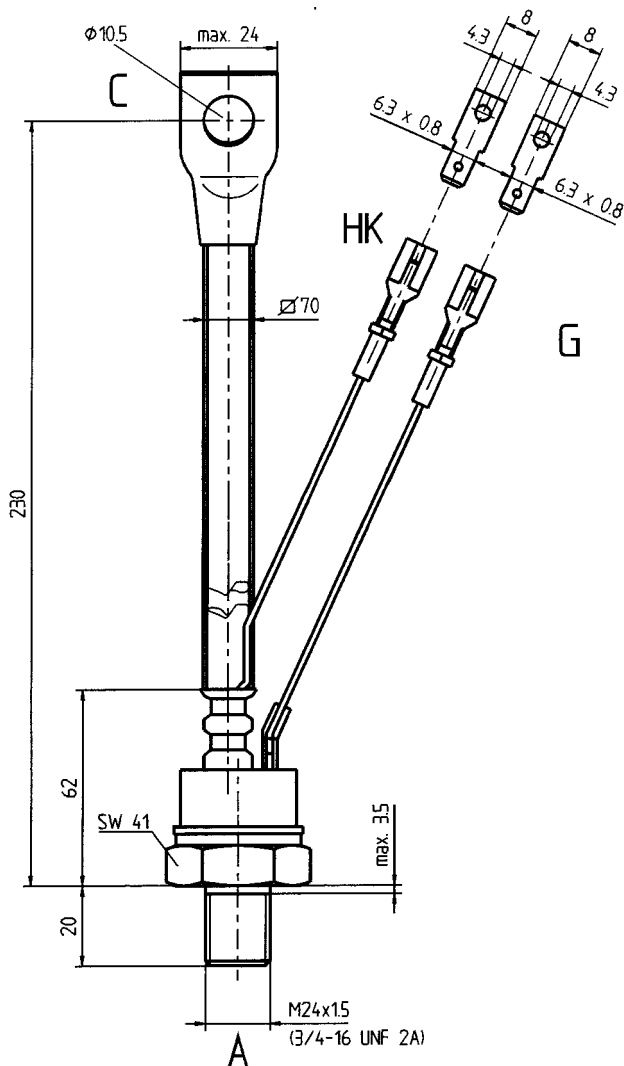

- C: Cathode terminal (red sleeve)    Dimensions in mm  
A: Anode terminal  
G: Gate terminal (yellow sleeve)  
HK: Auxiliary cathode terminal (red sleeve)